

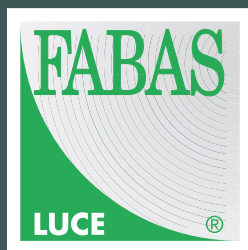

outdoor lighting

P R E V I E W 2 0 2 4



AULIX lighting

návrhy osvětlení a prodej svítidel
inteligentní systémy, vypínače

SVĚTELNÉ STUDIO

Náměstí Na Sádkách 705
252 41 Dolní Břežany (Praha západ)

Telefon: +420 246 083 152

Mobil.: +420 702 061 783

E-mail: studio@aulix.cz

Web: www.aulix.cz

E-shop: <http://obchod.aulix.cz>

Sledujte nás také na sociálních sítích:



outdoor lighting

PREVIEW 2024

Benvenuti nel mondo dell'illuminazione per gli spazi esterni firmata FABAS LUCE.

Un mondo fatto di soluzioni e variate possibilità per trasformare giardini, parchi, terrazze e cortili in scenari incantevoli, dove la luce gioca il ruolo principale.

Scoprite con noi il potenziale infinito della luce, anche per OUTDOOR.

Welcome to the world of lighting for outdoor by FABAS LUCE.

A world made of solutions and various possibilities to make enchanting scenarios for gardens, parks, terraces and courtyards, where the light plays the main role.

Discover with us the infinite potential of light.



Discover solar products



Le novità sono molte, in particolar modo i nostri **prodotti solari**, contrassegnati dal distintivo logo, sfruttano l'energia del sole attraverso pannelli solari integrati, che catturano e immagazzinano la luce solare durante il giorno per alimentare le lampade durante le ore serali.

Questa soluzione intelligente non solo **riduce i costi energetici a lungo termine**, ma contribuisce anche a **ridurre l'impatto ambientale**, consentendovi di illuminare gli spazi esterni in modo **sostenibile e responsabile**.

There are many new features especially our **solar products**, marked by distinctive logo, harness energy of the sun through solar panels integrated, which capture and store sunlight during the day to feed the lamps during the evening hours.

This smart solution does not only **reduce energy costs a long term**, but it contributes also to **reduce the environmental impact**, allowing you to light the outdoor spaces in a **sustainable and responsible way**.



Un intero programma dedicato all'illuminazione outdoor, pensato per coprire tutte le esigenze residenziali e professionali.

Elementi dal **design semplice e compatto**, capaci di integrarsi con la massima semplicità in qualsiasi contesto declinate **nelle versioni a LED integrato, solare e con lampadina GU10 e E27**.

Moltissime sono le novità presentate in questo nuovo catalogo: si tratta di prodotti di qualità, particolarmente interessanti per il loro uso illuminotecnico e decorativo negli spazi outdoor.

An entire dedicated program to outdoor lighting, designed to cover all residential and professional needs.

Products with **simple and compact design**, capable to be integrated with the maximum simplicity in any context available in **LED versions integrated, solar and with GU10 and E27 bulb**.

There are many new items presented in this new catalogue; these are products of quality, especially interesting for their technical and decorative use in outdoor spaces.

Seven chapters to inspire you

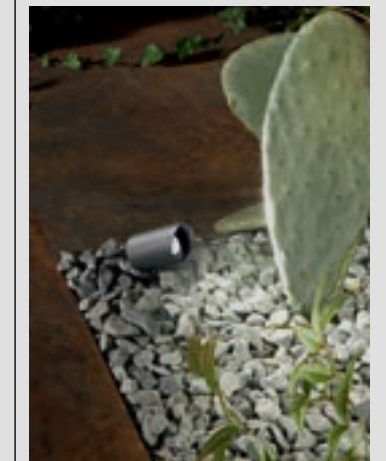

Esplora il nostro catalogo diviso in sette capitoli distinti: Paletti, Applique, Plafoniere, Luci Calpestabili, Segnapassi, Picchetti e Prodotti Portatili.

Ogni capitolo offre **soluzioni uniche per illuminare gli spazi esterni**, garantendo versatilità e stile in ogni ambiente.

Explore our catalogue divided into seven chapters: Bollards, Wall lamps, Ceiling lamps, Inground spots, Steplights, Pickets and Portable Products.

Each chapter offers **unique solutions to illuminate the outdoor spaces**, granting versatility and style in every different situation.

visual index

bollard



wall lamp



ceiling lamp



visual index

steplight

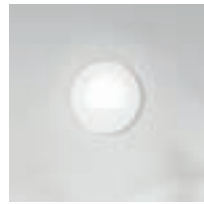

6571
glint
PAGE 84

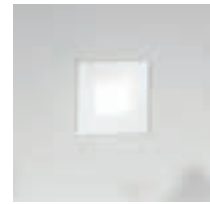

6572
dusk
PAGE 85



6573
wink
PAGE 86



6574
sway
PAGE 88

inground spot



6903
tulip 2
PAGE 92



6904
naire 2
PAGE 94



6905
willy 2
PAGE 96



6906
apache 2
PAGE 98



6907
irving 2
PAGE 100



6908
wako 2
PAGE 102



6909
abilene 2
PAGE 104



6910
yuma 2
PAGE 106

spike

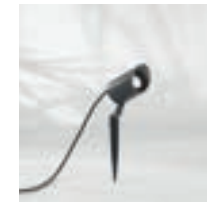

6575
tuc
PAGE 110



6550
boris
PAGE 112

portable lamp



3738 / 3745
blend
PAGE 116



3741 / 3745
clamp
PAGE 118

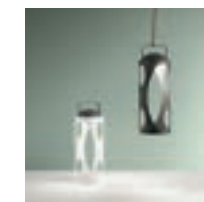

3740 / 3745
caddy
PAGE 120



3742
armanda
PAGE 122

bollard

elite

6534

Aluminium structure

bollard



elite 6534

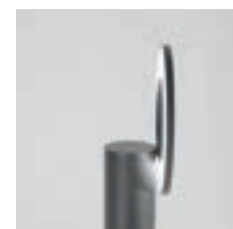
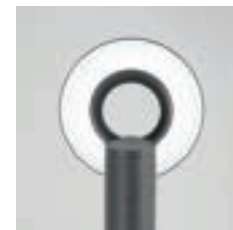
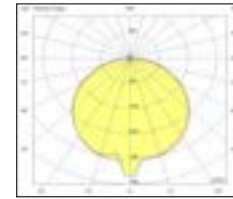

Adjustable and rotating head

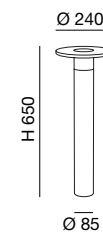

Wall lamp p. 36



Input voltage	Led type	Operating amb. temp.	Driver	Net weight	
100-240V AC 50/60 Hz	SMD	-20° +45°C	Included	2,1 Kg	310x310x715 3,95 Kg

Code	Finishing	Power	Color temper.	Lm Source	Lm System	CRI TYP
6534-10-294	Dark grey	10W	3000K	1309	799	83

CE  IP54  IK05

 
Energy Class Years Warranty

teo

6529

Aluminium structure

bollard



teo 6529

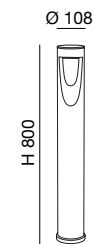
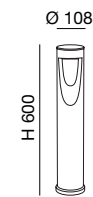
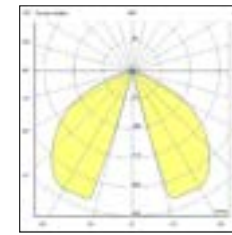
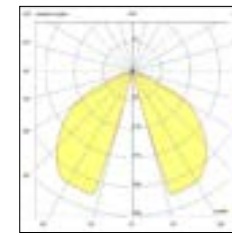
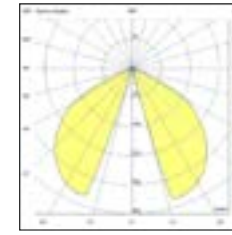

Input voltage	Led type	Operating amb. temp.	Driver	Net weight	
100-240V AC 50/60 Hz	COB	-20° +45°C	Included	1,29 Kg	125x125x320 1,47 Kg

Code	Finishing	Power	Color temper.	Lm Source	Lm System	CRI
6529-11-204	Shiny black	13W	3000K	1170	670	> 80

Input voltage	Led type	Operating amb. temp.	Driver	Net weight	
100-240V AC 50/60 Hz	COB	-20° +45°C	Included	2,0 Kg	125x125x620 2,3 Kg

Code	Finishing	Power	Color temper.	Lm Source	Lm System	CRI
6529-10-204	Shiny black	13W	3000K	1170	620	> 80

Input voltage	Led type	Operating amb. temp.	Driver	Net weight	
100-240V AC 50/60 Hz	COB	-20° +45°C	Included	2,33 Kg	125x125x820 2,67 Kg

Code	Finishing	Power	Color temper.	Lm Source	Lm System	CRI
6529-12-204	Shiny black	13W	3000K	1170	690	> 80

CE IP65 IK06

Energy Class 2 Years Warranty

nagi

6564

Aluminium structure

bollard



nagi 6564

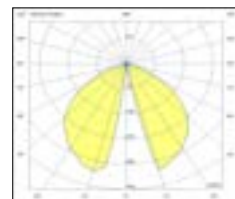

Adjustable head



Input voltage	Led type	Operating amb. temp.	Driver	Net weight	
220-240V AC 50/60 Hz	COB	-20° +45°C	Included	2,10 Kg	175x175x535 2,95 Kg

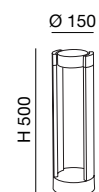

Code	Finishing	Power	Color temper.	Lm Source	Lm System	CRI TYP
6564-10-294	Dark grey	9W	3000K	722	354	83

CE  IP65  IK05

 A G F  2
Energy Class Years Warranty

spirit

6535

Aluminium structure

bollard



spirit 6535

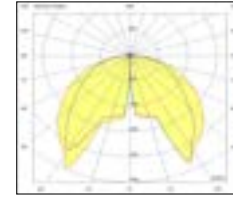

Wall lamp p. 38



Input voltage	Led type	Operating amb. temp.	Driver	Net weight	
220-240V AC 50/60 Hz	SMD	-20° +45°C	Included	1,08 Kg	165x165x535 1,55 Kg

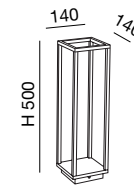

Code	Finishing	Power	Color temper.	Lm Source	Lm System	CRI TYP
6535-10-294	Dark grey	7W	3000K	978	200	82

CE  IP54  IK05

 A G D

 2

Energy Class Years Warranty

strike

6530

Aluminium structure



bollard

strike 6530

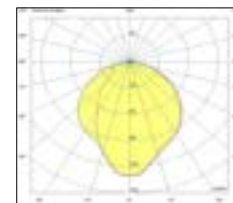

Input voltage	Led type	Operating amb. temp.	Driver	Net weight	
110-240V AC 50/60 Hz	SMD	-20° +45°C	Included	1,48 Kg	185x185x635 1,78 Kg

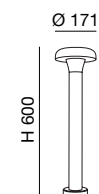

Code	Finishing	Power	Color temper.	Lm Source	Lm System	CRI
6530-10-294	Dark grey	12W	3000K	1704	580	> 80

CE  IP65  IK08

 **A++**
Energy Class

 **2**
Years Warranty

swen

6536

Aluminium structure

bollard



swen 6536

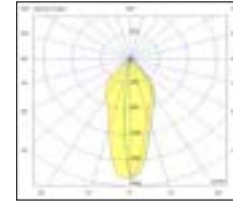

Input voltage	Led type	Operating amb. temp.	Driver	Net weight	
100-240V AC 50/60 Hz	COB	-20° +45°C	Included	1,6 Kg	155x135x685 2,43 Kg

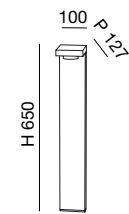

Code	Finishing	Power	Color temper.	Lm Source	Lm System	CRI TYP
6536-10-294	Dark grey	9W	3000K	680	350	83

CE IP54 IK05 Energy Class 2 Years Warranty

thiago

6566

Aluminium and polycarbonate structure

bollard



thiago 6566

Wall lamp p. 56



Input voltage	Lamp	Operating amb. temp.	Net weight	
Max 250V	E27	-20° +45°C	1,33 Kg	175x175x620 1,73 Kg

Code	Finishing	Power	Lm Source
6566-10-294	Dark grey	Max 1x15W	-

Input voltage	Lamp	Operating amb. temp.	Net weight	
Max 250V	E27	-20° +45°C	0,93 Kg	175x175x320 1,21 Kg

Code	Finishing	Power	Lm Source
6566-11-294	Dark grey	Max 1x15W	-

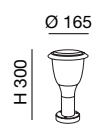
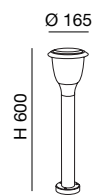

CE  IP65  IK08 

2
Years
Warranty

lena

6567

Aluminium and polycarbonate structure

bollard



lena 6567

Wall lamp p. 57



Input voltage	Lamp	Operating amb. temp.	Net weight	
Max 250V	E27	-20° +45°C	1,68 Kg	175x175x620 2,07 Kg

Code	Finishing	Power	Lm Source
6567-10-294	Dark grey	Max 1x15W	-

Input voltage	Lamp	Operating amb. temp.	Net weight	
Max 250V	E27	-20° +45°C	1,09 Kg	175x175x320 1,35 Kg

Code	Finishing	Power	Lm Source
6567-11-294	Dark grey	Max 1x15W	-

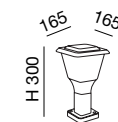
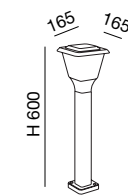

CE  IP65  IK08 

 2
Years
Warranty

gorla

6554

Aluminium and polycarbonate structure

Wall lamp p. 58



Input voltage	Lamp	Operating amb. temp.	Net weight	
Max 250V	E27	-20° +45°C	1,3 Kg	115x115x675 1,95 Kg

bollard

Ø 90



Code	Finishing	Power	Lm Source
6554-10-294	Dark grey	Max 1x15W	-

smuk

6537

Aluminium and polycarbonate structure

Wall lamp p. 59



Input voltage	Lamp	Operating amb. temp.	Net weight	
Max 250V	E27	-20° +45°C	2,5 Kg	115x115x665 3,13 Kg

108 108

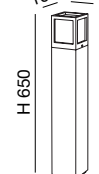

Code	Finishing	Power	Lm Source
6537-10-294	Dark grey	Max 1x20W	-

palmer

6539

Aluminium structure.

Our bollard lights up at the minimum (15%) to save energy at sunset. But as soon as it detects movement within 6 meters, it lights up to 100%. Safe and efficient, always ready when needed.



bollard



palmer 6539

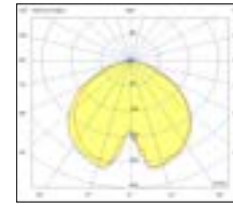

Wall lamp p. 35



Input voltage	Led type	Operating amb. temp.	Driver	Net weight		Charge	Work time
3,7 VDC (Li-ion Battery)	SMD	-0° +45°C	Included	1,23 Kg	220x220x670 2,13 Kg	5-7 h	2,5 h (100%) 22 h (15%)

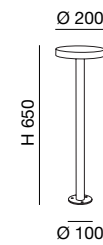

Code	Finishing	Power	Color temper.	Lm Source	Lm System	CRI TYP
6539-10-299	Dark grey	2,7W	3000K	383	246	81

Spike included
 Crepuscular Sensor (20 lux)
 Motion Sensor
 Energy Class
 2 Years Warranty

fold

6538

Aluminium structure.

Our bollard lights up at the minimum (15%) to save energy at sunset. But as soon as it detects movement within 6 meters, it lights up to 100%. Safe and efficient, always ready when needed.



bollard

fold 6538

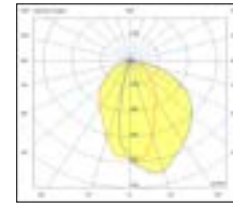

Input voltage	Led type	Operating amb. temp.	Driver	Net weight	Charge	Work time
3,7 VDC (Li-ion Battery)	SMD	-0° +45°C	Included	2,65 Kg	165x165x535 3,6 Kg	3 h (100%) 24 h (15%)

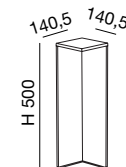

Code	Finishing	Power	Color temper.	Lm Source	Lm System	CRI TYP
6538-10-299	Dark grey	2,7W	3000K	388	185	81

wall lamp

palmer

6539

Aluminium and polycarbonate structure.

Our wall lamps lights up at the minimum (15%) to save energy at sunset. But as soon as it detects movement within 6 meters, it lights up to 100%. Safe and efficient, always ready when needed.

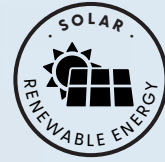

wall lamp

palmer 6539

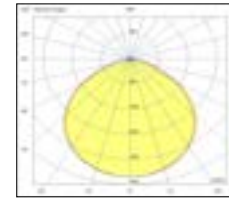

Bollard p. 28



Input voltage	Led type	Operating amb. temp.	Driver	Net weight	Charge	Work time
3,7 VDC (Li-ion Battery)	SMD	-0° +45°C	Included	0,76 Kg	210x50x205 1,04 Kg	3 h (100%) 24 h (15%)

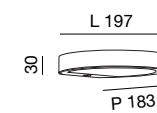

Code	Finishing	Power	Color temper.	Lm Source	Lm System	CRI TYP
6539-21-299	Dark grey	2,7W	3000K	385	276	81

elite

6534

Aluminium and polycarbonate structure

wall lamp



elite 6534

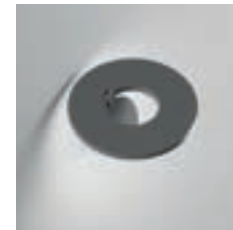
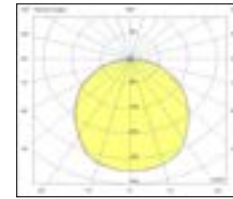

Adjustable and rotating head

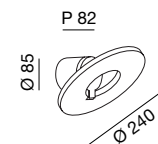

Bollard p. 11

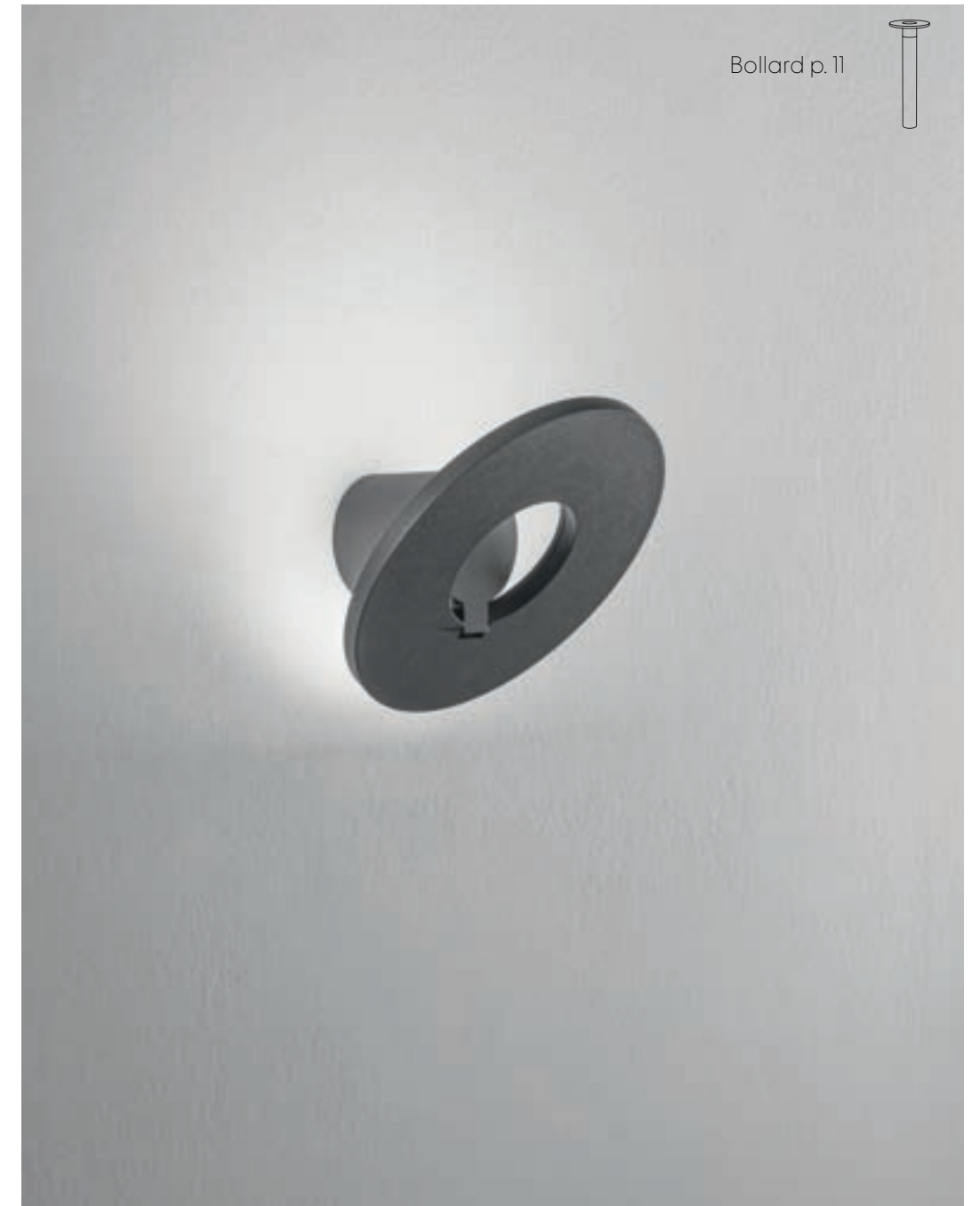
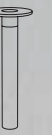

Input voltage	Led type	Operating amb. temp.	Driver	Net weight	
100-240V AC 50/60 Hz	SMD	-20° +45°C	Included	0,93 Kg	290x142x290 1,43 Kg

Code	Finishing	Power	Color temper.	Lm Source	Lm System	CRI TYP
6534-21-294	Dark grey	10W	3000K	1309	832	83

CE  IP54  IK05

 **A**  **2**
Energy Class Years Warranty

spirit

6535

Aluminium and polycarbonate structure

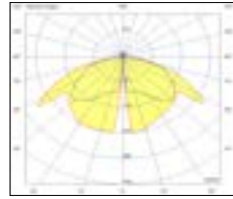

Bollard p. 16



Input voltage	Led type	Operating amb. temp.	Driver	Net weight	
220-240V AC 50/60 Hz	SMD	-20° +45°C	Included	0,90 Kg	155x145x275 1,2 Kg

wall lamp

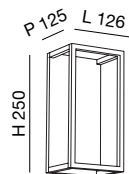

Code	Finishing	Power	Color temper.	Lm Source	Lm System	CRI TYP
6535-21-294	Dark grey	8W	3000K	1022	292	83

edo

6556

Aluminium and polycarbonate structure

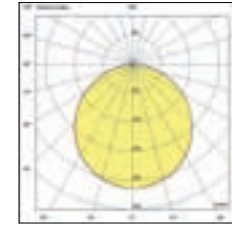

Input voltage	Led type	Operating amb. temp.	Driver	Net weight	
220-240V AC 50/60 Hz	SMD	-5° +45°C	Included	0,85 Kg	165x95x310 1,13 Kg

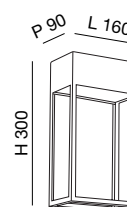

Code	Finishing	Power	Color temper.	Lm Source	Lm System	CRI TYP
6556-21-294	Anthracite	20W	3000K	2396	1381	94

jason

6540

Aluminium and methacrylate structure

wall lamp



jason 6540

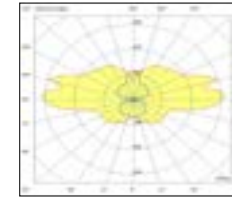
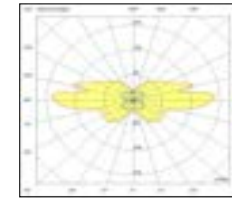

Input voltage	Led type	Operating amb. temp.	Driver	Net weight	
220-240V AC 50/60 Hz	SMD	-5° +45°C	Included	1,3 Kg	665x110x80 1,55 Kg

Code	Finishing	Power	Color temper.	Lm Source	Lm System	CRI TYP
6540-21-254	White	17W	3000K	1796	1390	91
6540-21-294	Dark grey	17W	3000K	1796	1339	91

Input voltage	Led type	Operating amb. temp.	Driver	Net weight	
220-240V AC 50/60 Hz	SMD	-5° +45°C	Included	1,9 Kg	1065x110x80 2,25 Kg

Code	Finishing	Power	Color temper.	Lm Source	Lm System	CRI TYP
6540-22-254	White	22W	3000K	2993	2235	91
6540-22-294	Dark grey	22W	3000K	2993	2164	91

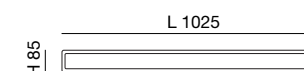
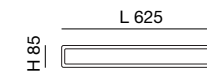

CE IP65 IK06

Energy Class **A** Years Warranty **2**

Iuly

6561

Aluminium structure

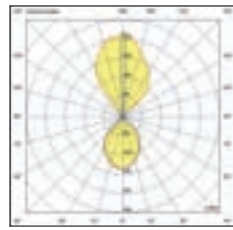
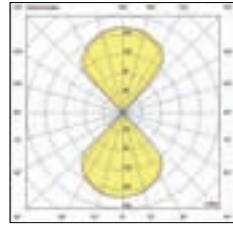

Input voltage	Led type	Operating amb. temp.	Driver	Net weight	
220-240V AC 50/60 Hz	SMD	-20° +45°C	Included	0,58 Kg	80x75x165 0,63 Kg

wall lamp

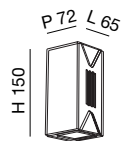

Code	Finishing	Power	Color temper.	Lm Source	Lm System	CRI
6561-22-094	Dark grey	6W	3000K	500	170	> 80
6561-22-794	Dark grey	6W	3000K	500	284	> 80

heli

6559

Aluminium structure

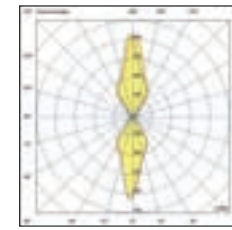
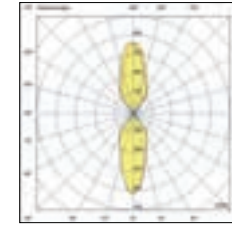

Input voltage	Led type	Operating amb. temp.	Driver	Net weight	
100-240V AC 50/60 Hz	COB	-20° +45°C	Included	0,46 Kg	80x75x165 0,5 Kg

Code	Finishing	Power	Color temper.	Lm Source	Lm System	CRI
6559-22-294	Dark grey	6W	3000K	780	597	> 80

Input voltage	Led type	Operating amb. temp.	Driver	Net weight	
100-240V AC 50/60 Hz	COB	-20° +45°C	Included	0,78 Kg	110x110x210 0,84 Kg

Code	Finishing	Power	Color temper.	Lm Source	Lm System	CRI
6559-26-294	Dark grey	12W	3000K	1416	1140	> 80

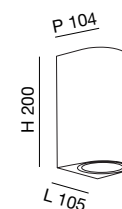
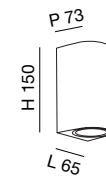

cuba

6541

Aluminium structure, adjustable beam angle

wall lamp



Input voltage	Led type	Operating amb. temp.	Driver	Net weight	
220-240V AC 50/60 Hz	COB	-5° +45°C	Included	0,50 Kg	110x110x110 0,6 Kg

Code	Finishing	Power	Color temper.	Lm Source	Lm System	CRI TYP
6541-21-294	Dark grey	12W	3000K	1448	685	83
6541-21-254	White	12W	3000K	1448	685	83
6541-21-284	Corten	12W	3000K	1448	685	83





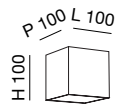



cody

6542

Aluminium structure, adjustable beam angle



Input voltage	Led type	Operating amb. temp.	Driver	Net weight	
220-240V AC 50/60 Hz	COB	-5° +45°C	Included	0,55 Kg	150x120x110 0,65 Kg

Code	Finishing	Power	Color temper.	Lm Source	Lm System	CRI TYP
6542-21-294	Dark grey	12W	3000K	1448	685	83
6542-21-254	White	12W	3000K	1448	685	83
6542-21-284	Corten	12W	3000K	1448	685	83



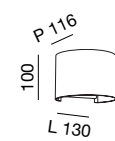

zon

6544

Aluminium and polycarbonate structure

wall lamp



zon 6544



Input voltage	Led type	Operating amb. temp.	Driver	Net weight	
220-240V AC 50/60 Hz	SMD	-5° +45°C	Included	0,73 Kg	190x195x50 0,88 Kg

Code	Finishing	Power	Color temper.	Lm Source	Lm System	CRI TYP
6544-21-294	Dark grey	9W	3000K	1017	672	91
6544-21-254	White	9W	3000K	1017	755	91
6544-21-284	Corten	9W	3000K	1017	672	91

Input voltage	Led type	Operating amb. temp.	Driver	Net weight	
220-240V AC 50/60 Hz	SMD	-5° +45°C	Included	1,2 Kg	285x285x90 1,49 Kg

Code	Finishing	Power	Color temper.	Lm Source	Lm System	CRI TYP
6544-22-294	Dark grey	12W	3000K	1356	816	91
6544-22-254	White	12W	3000K	1356	1197	91
6544-22-284	Corten	12W	3000K	1356	816	91

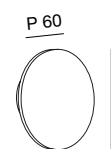
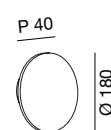

CE  IP65 IK06

 **A** **D**
Energy Class

 **2**
Years Warranty

hazel

3680

Metal and wood frame and plate glass

wall lamp



hazel 3680



Input voltage	Led type	Operating amb. temp.	Driver	Net weight	
220-240V AC 50/60 Hz	SMD	-10° +40°C	Included	0,93 Kg	 250x140x125 1,16 Kg

Code	Finishing	Power	Color temper.	Lm Source	Lm System	CRI
3680-22-165	Teak wood	13W	3000K	1250	809	> 80

Input voltage	Led type	Operating amb. temp.	Driver	Net weight	
220-240V AC 50/60 Hz	SMD	-10° +40°C	Included	1,84 Kg	 405x140x125 2,03 Kg

Code	Finishing	Power	Color temper.	Lm Source	Lm System	CRI
3680-29-165	Teak wood	20W	3000K	2350	1030	> 80

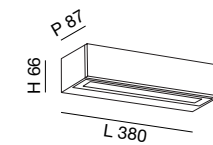
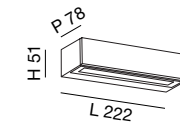

CE  IP65  IK07

 F
Energy Class
3680-22-165

 E
Energy Class
3680-29-165

 2
Years
Warranty

lao

3603

Aluminium frame and crystal glass

wall lamp



lao 3603



Input voltage	Led type	Operating amb. temp.	Driver	Net weight	
220-240V AC 50/60 Hz	COB	-10° +40°C	Included	0,85 Kg	150x160x160 0,95 Kg

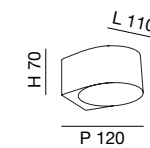
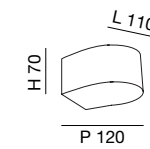

Code	Finishing	Power	Color temper.	Lm Source	Lm System	CRI
3603-21-101	Black	6W	3000K	540	509	> 80
3603-21-102	White	6W	3000K	540	509	> 80

Code	Finishing	Power	Color temper.	Lm Source	Lm System	CRI
3603-22-101	Black	12W	3000K	1080	1021	> 80
3603-22-102	White	12W	3000K	1080	1021	> 80

CE  IP65 IK06

 Energy Class **A**
 Years Warranty **2**

trigg

6786

Aluminum frame

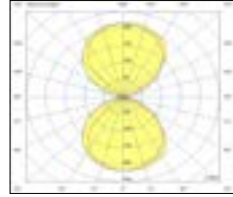

Input voltage	Led type	Operating amb. temp.	Driver	Net weight	
220-240V AC 50/60 Hz	SMD	-10° +35°C	Included	0,70 Kg	75x190x80 0,80 Kg

wall lamp

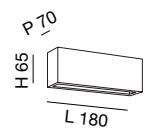

Code	Finishing	Power	Color temper.	Lm Source	Lm System	CRI
6786-02-844	Silver	14W	3000K	1300	920	> 80
6786-02-854	White	14W	3000K	1300	920	> 80

ector

6543

Aluminium and polycarbonate structure

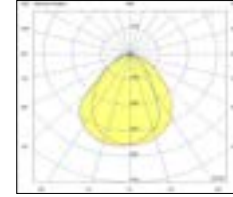

Input voltage	Led type	Operating amb. temp.	Driver	Net weight	
220-240V AC 50/60 Hz	SMD	-5° +45°C	Included	0,62 Kg	180x160x70 0,77 Kg

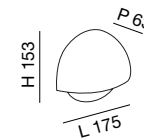

Code	Finishing	Power	Color temper.	Lm Source	Lm System	CRI
6543-21-254	White	10W	3000K	990	858	> 80
6543-21-294	Dark grey	10W	3000K	990	805	> 80

pix

6563

Aluminium and polycarbonate structure

wall lamp



Input voltage	Lamp	Operating amb. temp.	Net weight	
Max 250V	E27	-20° +45°C	0,9 Kg	135x120x275 1,01 Kg

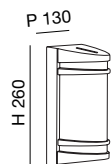

Code	Finishing	Power	Lm Source
6563-21-294	Dark grey	Max 1x15W	-







gluck

6562

Aluminium and polycarbonate structure



Input voltage	Lamp	Operating amb. temp.	Net weight	
Max 250V	E27	-20° +45°C	0,83 Kg	135x120x275 0,94 Kg

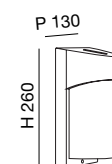

Code	Finishing	Power	Lm Source
6562-21-294	Dark grey	Max 1x15W	-







thiago

6566

Aluminium and polycarbonate structure

Bollard p. 22



Input voltage	Lamp	Operating amb. temp.	Net weight	
Max 250V	E27	-20° +45°C	0,98 Kg	250x170x305 1,31 Kg

wall lamp

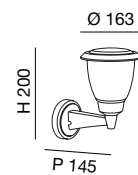

Code	Finishing	Power	Lm Source
6566-21-294	Dark grey	Max 1x15W	-

lena

6567

Aluminium and polycarbonate structure

Bollard p. 24



Input voltage	Lamp	Operating amb. temp.	Net weight	
Max 250V	E27	-20° +45°C	0,96 Kg	265x175x285 1,25 Kg

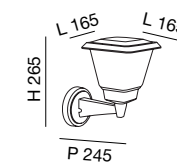

Code	Finishing	Power	Lm Source
6567-21-294	Dark grey	Max 1x15W	-

gorla

6554

Aluminium and polycarbonate structure

wall lamp



Input voltage	Lamp	Operating amb. temp.	Net weight	
Max 250V	E27	-20° +45°C	0,9 Kg	155x115x265 1,28 Kg

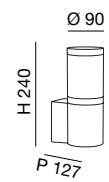

Code	Finishing	Power	Lm Source
6554-21-294	Dark grey	Max 1x15W	-







smuk

6537

Aluminium and polycarbonate structure



Input voltage	Lamp	Operating amb. temp.	Net weight	
Max 250V	E27	-20° +45°C	1,47 Kg	155x115x255 1,68 Kg

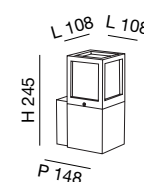

Code	Finishing	Power	Lm Source
6537-21-294	Dark grey	Max 1x20W	-







glammy

6545

Aluminium and polycarbonate structure

wall lamp



Input voltage	Lamp	Operating amb. temp.	Net weight	
Max 250V	E27	-20° +45°C	1,28 Kg	280x155x285 1,98 Kg

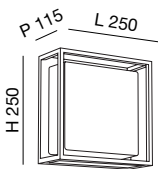

Code	Finishing	Power	Lm Source
6545-21-794	Dark grey	Max 2x15W	-

clip

6555

Aluminium and polycarbonate structure

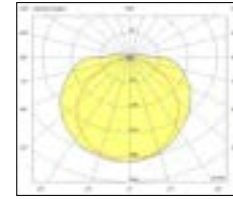

Input voltage	Led type	Operating amb. temp.	Driver	Net weight	
220-240V AC 50/60 Hz	SMD	-5° +45°C	Included	0,55 Kg	120x110x700 0,81 Kg

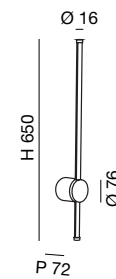

Code	Finishing	Power	Color temper.	Lm Source	Lm System	CRI TYP
6555-21-294	Dark grey	12W	3000K	1650	890	93

ceiling lamp

owen

6547

Aluminium and polycarbonate structure



ceiling lamp

owen 6547

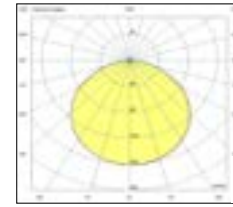

Input voltage	Led type	Operating amb. temp.	Driver	Net weight	
100-240V AC 50/60 Hz	SMD	-20° +45°C	Included	1,2 Kg	235x80x235 1,31 Kg

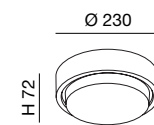

Code	Finishing	Power	Color temper.	Lm Source	Lm System	CRI
6547-61-294	Dark grey	12W	3000K	1620	950	> 80

CE IP65 IK08

Energy Class **A**
 3 Years Warranty

diuk

6548

Aluminium and polycarbonate structure

ceiling lamp

diuk 6548

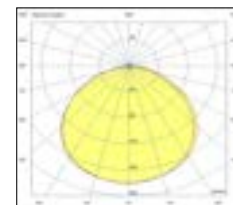

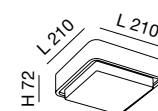

Input voltage	Led type	Operating amb. temp.	Driver	Net weight	
100-240V AC 50/60 Hz	SMD	-20° +45°C	Included	1,39 Kg	215x80x215 1,47 Kg



Code	Finishing	Power	Color temper.	Lm Source	Lm System	CRI
6548-61-294	Dark grey	12W	3000K	1620	980	> 80

CE  IP65  IK08

 Energy Class **A**
 Years Warranty **3**

desdy

3314

Aluminium and polycarbonate structure

ceiling lamp



desdy 3314

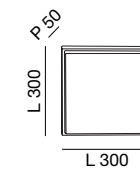
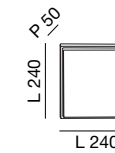
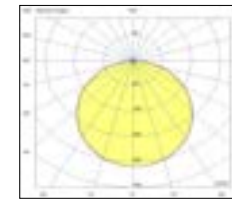
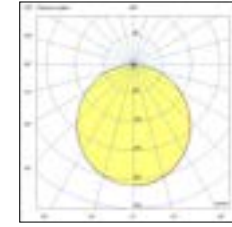
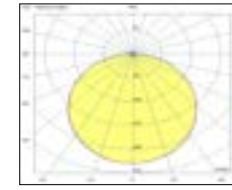

Input voltage	Led type	Operating amb. temp.	Driver	Net weight	
220-240V AC 50/60 Hz	SMD	-10° +40°C	Included	0,6 Kg	60x185x185 0,7 Kg

Code	Finishing	Power	Color temper.	Lm Source	Lm System	CRI
3314-69-101	Black	10W	3000K	1050	867	> 80
3314-69-102	White	10W	3000K	1050	867	> 80

Input voltage	Led type	Operating amb. temp.	Driver	Net weight	
220-240V AC 50/60 Hz	SMD	-10° +40°C	Included	1 Kg	60x255x255 1,1 Kg

Code	Finishing	Power	Color temper.	Lm Source	Lm System	CRI
3314-61-101	Black	23W	3000K	2700	2272	> 80
3314-61-102	White	23W	3000K	2700	2272	> 80

Input voltage	Led type	Operating amb. temp.	Driver	Net weight	
220-240V AC 50/60 Hz	SMD	-10° +40°C	Included	1,50 Kg	60x315x315 1,6 Kg

Code	Finishing	Power	Color temper.	Lm Source	Lm System	CRI
3314-65-101	Black	30W	3000K	3220	2560	> 80
3314-65-102	White	30W	3000K	3220	2560	> 80

CE IP54 IK10

Energy Class **A** 3 Years Warranty

olly

3315

Aluminium and polycarbonate structure

ceiling lamp



olly 3315

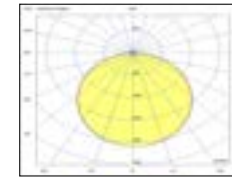
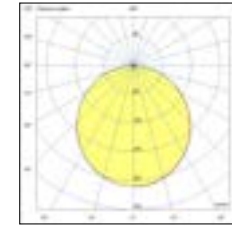
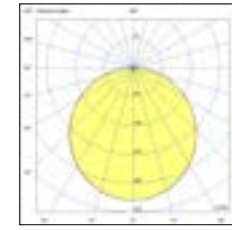

Input voltage	Led type	Operating amb. temp.	Driver	Net weight	
220-240V AC 50/60 Hz	SMD	-10° +40°C	Included	0,5 Kg	60x185x185 0,6 Kg

Code	Finishing	Power	Color temper.	Lm Source	Lm System	CRI
3315-69-101	Black	10W	3000K	1050	867	> 80
3315-69-102	White	10W	3000K	1050	867	> 80

Input voltage	Led type	Operating amb. temp.	Driver	Net weight	
220-240V AC 50/60 Hz	SMD	-10° +40°C	Included	0,8 Kg	60x255x255 0,9 Kg

Code	Finishing	Power	Color temper.	Lm Source	Lm System	CRI
3315-61-101	Black	23W	3000K	2700	2272	> 80
3315-61-102	White	23W	3000K	2700	2272	> 80

Input voltage	Led type	Operating amb. temp.	Driver	Net weight	
220-240V AC 50/60 Hz	SMD	-10° +40°C	Included	1,20 Kg	60x315x315 1,4 Kg

Code	Finishing	Power	Color temper.	Lm Source	Lm System	CRI
3315-65-101	Black	30W	3000K	3220	2560	> 80
3315-65-102	White	30W	3000K	3220	2560	> 80

CE IP54 IK10



manu

6565

Aluminium structure

ceiling lamp



manu 6565



Input voltage	Lamp	Operating amb. temp.	Net weight	
Max 250V	E27	-20° +45°C	0,8 Kg	125x125x180 0,88 Kg

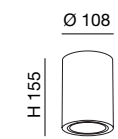

Code	Finishing	Power	Lm Source
6565-61-294	Dark grey	Max 1x15W	-

CE  IP54  IK05 

3
Years
Warranty

gian

6577

Aluminium structure

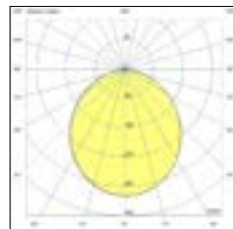
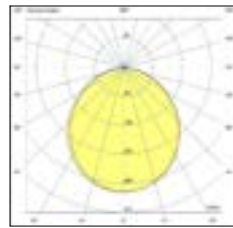
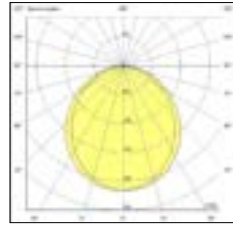

ceiling lamp

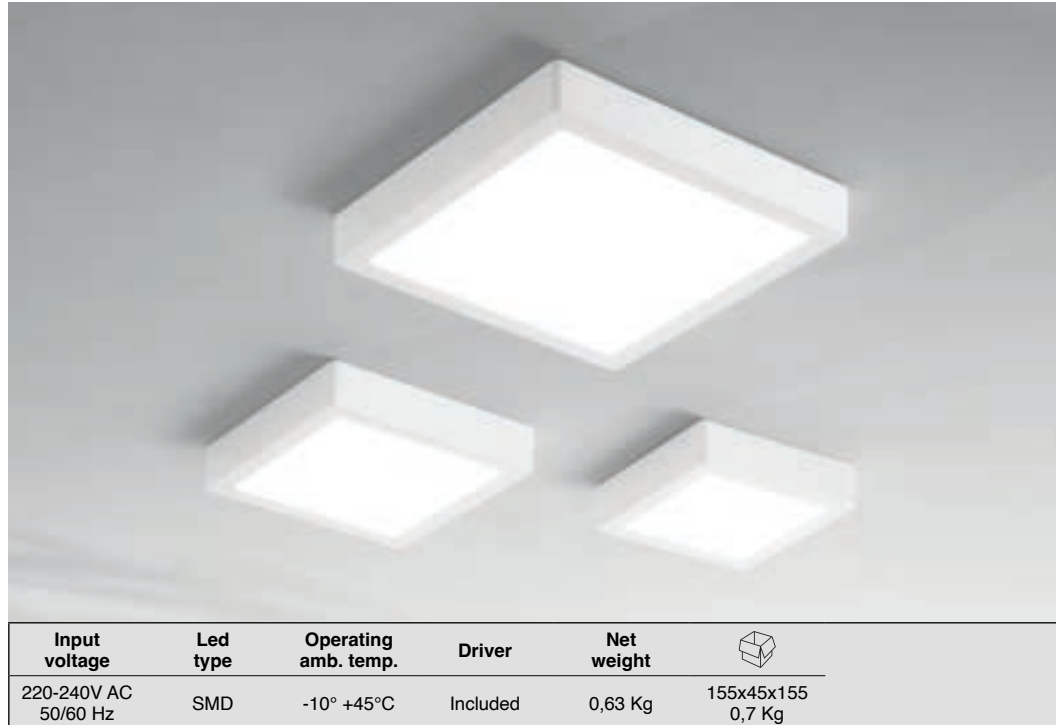
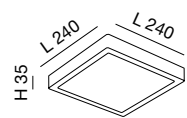
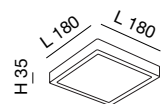
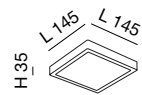

Input voltage	Led type	Operating amb. temp.	Driver	Net weight	
220-240V AC 50/60 Hz	SMD	-10° +45°C	Included	0,63 Kg	155x45x155 0,7 Kg

Code	Finishing	Power	Color temper.	Lm Source	Lm System	CRI
6577-61-254	Ivory white	12W	3000K	1344	960	> 80

Input voltage	Led type	Operating amb. temp.	Driver	Net weight	
220-240V AC 50/60 Hz	SMD	-10° +45°C	Included	0,9 Kg	190x45x190 1 Kg

Code	Finishing	Power	Color temper.	Lm Source	Lm System	CRI
6577-65-254	Ivory white	18W	3000K	2295	1530	> 80

Input voltage	Led type	Operating amb. temp.	Driver	Net weight	
220-240V AC 50/60 Hz	SMD	-10° +45°C	Included	1,41 Kg	250x45x250 1,54 Kg

Code	Finishing	Power	Color temper.	Lm Source	Lm System	CRI
6577-64-254	Ivory white	24W	3000K	3060	2040	> 80

nicole cct

6576

Aluminium structure

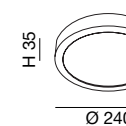
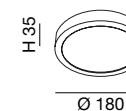
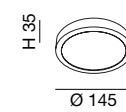
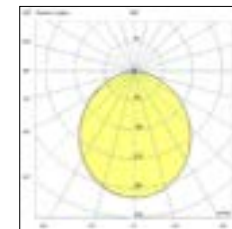
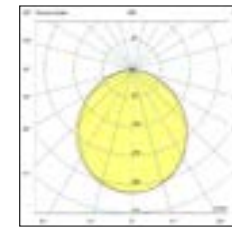
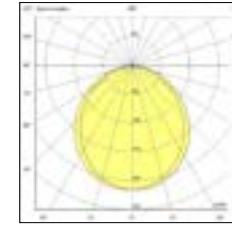

Input voltage	Led type	Operating amb. temp.	Driver	Net weight	
220-240V AC 50/60 Hz	SMD	-10° +45°C	Included	0,57 Kg	155x45x155 0,63 Kg

Code	Finishing	Power	Color temper.	Lm Source	Lm System	CRI
6576-61-254	Ivory white	8W	2700K/3000K/4000K	896	640	> 80

Input voltage	Led type	Operating amb. temp.	Driver	Net weight	
220-240V AC 50/60 Hz	SMD	-10° +45°C	Included	0,79 Kg	190x45x190 0,9 Kg

Code	Finishing	Power	Color temper.	Lm Source	Lm System	CRI
6576-65-254	Ivory white	14W	2700K/3000K/4000K	1785	1190	> 80

Input voltage	Led type	Operating amb. temp.	Driver	Net weight	
220-240V AC 50/60 Hz	SMD	-10° +45°C	Included	1,39 Kg	250x45x250 1,53 Kg

Code	Finishing	Power	Color temper.	Lm Source	Lm System	CRI
6576-64-254	Ivory white	18W	2700K/3000K/4000K	2295	1530	> 80

oban

3225/3233

Policarbonate structure

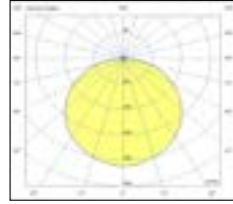

ceiling lamp



Input voltage	Lamp	Operating amb. temp.	Net weight	
Max 250V	E27	-20° +40°C	0,73 Kg	100x250x250 0,90 Kg

Code	Finishing	Power	
3225-61-102	White	Max 1x42W	Motion sensor
3233-61-102	White	Max 1x42W	

Input voltage	Lamp	Operating amb. temp.	Net weight	
Max 250V	E27	-20° +40°C	1,04 Kg	100x310x310 1,26 Kg

Code	Finishing	Power	
3225-65-102	White	Max 2x30W	Motion sensor
3233-65-102	White	Max 2x30W	

CE IP65 IK10 3 Years Warranty

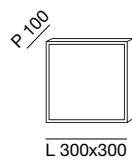
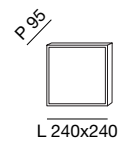

hatton

3226/3229

Policarbonate structure

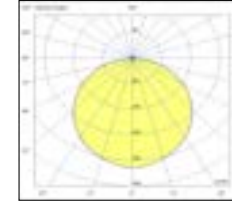

Input voltage	Lamp	Operating amb. temp.	Net weight	
Max 250V	E27	-20° +40°C	0,60 Kg	100x250x250 0,76 Kg

Code	Finishing	Power	
3226-61-102	White	Max 1x42W	Motion sensor
3229-61-102	White	Max 1x42W	

Input voltage	Lamp	Operating amb. temp.	Net weight	
Max 250V	E27	-20° +40°C	0,86 Kg	105x310x310 1,09 Kg

Code	Finishing	Power	
3226-65-102	White	Max 2x30W	Motion sensor
3229-65-102	White	Max 2x30W	

CE IP65 IK10 3 Years Warranty

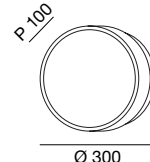
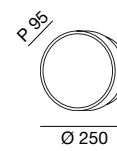

folk

3526

Polycarbonate structure

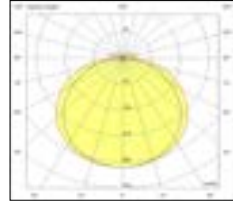

Input voltage	Led type	Operating amb. temp.	Driver	Net weight	
220-240V AC 50/60 Hz	SMD	-20° +45°C	Included	0,9 Kg	295x75x300 1,2 Kg

ceiling lamp

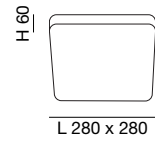

Code	Finishing	Power	Color temper.	Lm Source	Lm System	CRI
3526-61-102	White	27W	3000K	2500	1800	> 80

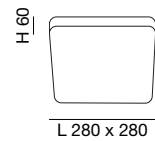

Code	Finishing	Power	Color temper.	Lm Source	Lm System	CRI
3526-63-102	White	27W	3000K	2500	1800	> 80

Motion sensor

trigo

3525

Polycarbonate structure

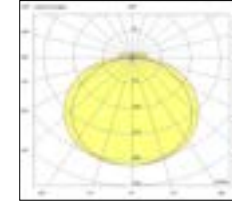

Input voltage	Led type	Operating amb. temp.	Driver	Net weight	
220-240V AC 50/60 Hz	SMD	-20° +45°C	Included	0,8 Kg	295x75x300 1,1 Kg

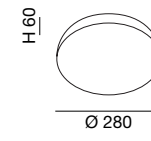

Code	Finishing	Power	Color temper.	Lm Source	Lm System	CRI
3525-61-102	White	27W	3000K	2500	1800	> 80

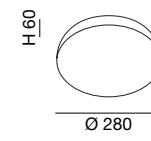

Code	Finishing	Power	Color temper.	Lm Source	Lm System	CRI
3525-63-102	White	27W	3000K	2500	1800	> 80

Motion sensor

pandora

2650

Metal frame and blown glass

ceiling lamp



Input voltage	Lamp	Operating amb. temp.	Net weight	
Max 250V	E27	-10° +45°C	1,39 Kg	140x360x360 1,9 Kg

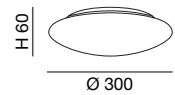

Code	Finishing	Power	Lm Source
2650-61-102	White	Max 60W	-









armilla

2796

Policarbonate structure

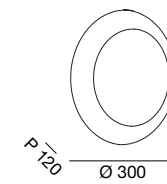

Input voltage	Lamp	Operating amb. temp.	Net weight	
Max 250V	E27	-10° +45°C	0,73 Kg	115x310x310 0,95 Kg



Code	Finishing	Power	Lm Source
2796-61-102	White	Max 60W	-
2796-61-137	Silver	Max 60W	-









steplight

glint

6571

Aluminium and plate glass structure

steplight



Input voltage	Led type	Operating amb. temp.	Driver	Net weight	
24 VDC	SMD	-20° +50°C	Not included	0,20 Kg	85x85x95 0,24 Kg

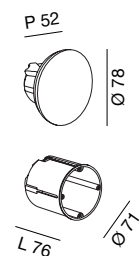

Code	Finishing	Power	Color temper.	Lm Source	Lm System	CRI TYP
6571-02-254	White	2,2W	3000K	146	16	90
6571-50-001	Outer casing					



 IP65 IK06
 



dusk

6572



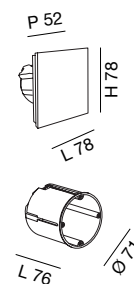

Aluminium and plate glass structure



Input voltage	Led type	Operating amb. temp.	Driver	Net weight	
24 VDC	SMD	-20° +50°C	Not included	0,21 Kg	85x85x95 0,24 Kg



Code	Finishing	Power	Color temper.	Lm Source	Lm System	CRI TYP
6572-02-254	White	2,2W	3000K	146	18	90
6571-50-001	Outer casing					



 IP65 IK06
 

wink

6573

Die-casting structure

steplight



wink 6573



Input voltage	Led type	Operating amb. temp.	Driver	Net weight	
220-240V AC 50/60 Hz	COB	-10° +45°C	Included	0,32 Kg	115x110x85 0,38 Kg

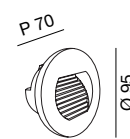

Code	Finishing	Power	Color temper.	Lm Source	Lm System	CRI
6573-02-294	Grey	3W	3000K	160	100	> 80
6573-02-254	White	3W	3000K	160	100	> 80

CE  IP65  IK06

 **A** **F**
Energy Class

 **2**
Years Warranty

sway

6574

Die-casting structure

steplight



sway 6574



Input voltage	Led type	Operating amb. temp.	Driver	Net weight	
220-240V AC 50/60 Hz	COB	-10° +45°C	Included	0,38 Kg	115x110x85 0,38 Kg

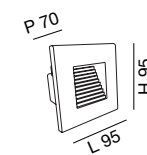

Code	Finishing	Power	Color temper.	Lm Source	Lm System	CRI
6574-02-294	Grey	3W	3000K	160	100	> 80
6574-02-254	White	3W	3000K	160	100	> 80







inground spot

tulip 2

6903

Drive-over spot light. Application with outer casing.
Outer casing included. Frame made of AISI 316 stainless steel.

inground spot



tulip 2 6903



Input voltage	Led type	Operating amb. temp.	Driver	Net weight	
220-240V AC 50/60 Hz	SMD	-20° +40°C	Included	0,40 Kg	95x150x95 0,5 Kg

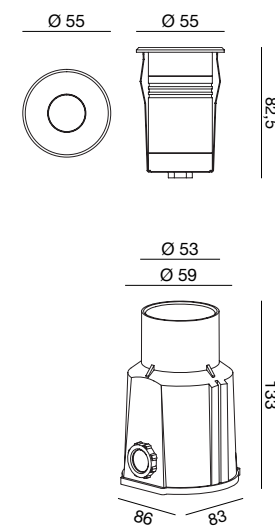

Code	Finishing	Power	Color temper.	Lm Source	Lm System	CRI TYP
6903-02-314	Stainless steel	3W	3000K	175 lm	152	82

naire 2

6904

Drive-over spot light. Application with outer casing.
Outer casing included. Frame made of AISI 316 stainless steel.

inground spot

naire 2 6904

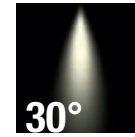

Input voltage	Led type	Operating amb. temp.	Driver	Net weight	
220-240V AC 50/60 Hz	SMD	-20° +40°C	Included	0,40 Kg	95x150x95 0,5 Kg

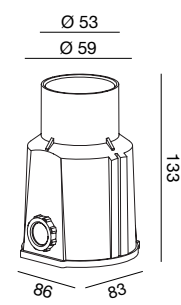
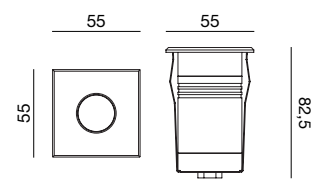

Code	Finishing	Power	Color temper.	Lm Source	Lm System	CRI TYP
6904-02-314	Stainless steel	3W	3000K	175 lm	152	82

willy 2

6905

Drive-over spot light. Application with outer casing.
Outer casing included. Frame made of AISI 316 stainless steel.

inground spot



willy 2 6905



Input voltage	Led type	Operating amb. temp.	Driver	Net weight	
220-240V AC 50/60 Hz	COB	-20° +40°C	Included	0,50 Kg	95x150x95 0,6 Kg

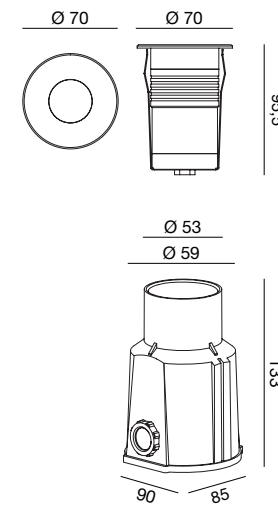

Code	Finishing	Power	Color temper.	Lm Source	Lm System	CRI
6905-02-414	Stainless steel	6,5W	3000K	480 lm	409	> 80









apache 2

6906

Drive-over spot light. Application with outer casing.
Outer casing included. Frame made of AISI 316 stainless steel.

inground spot



apache 2 6906



Input voltage	Led type	Operating amb. temp.	Driver	Net weight	
220-240V AC 50/60 Hz	COB	-20° +40°C	Included	0,60 Kg	95x150x95 0,7 Kg

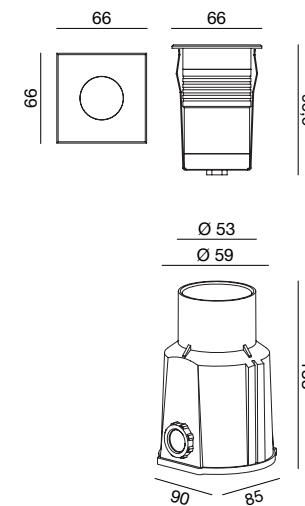

Code	Finishing	Power	Color temper.	Lm Source	Lm System	CRI
6906-02-414	Stainless steel	6,5W	3000K	480 lm	409	> 80

irving 2

6907

Drive-over spot light. Application with outer casing.
Outer casing included.
Frame made of AISI 316 stainless steel.

inground spot

irving 2 6907



Input voltage	Led type	Operating amb. temp.	Driver	Net weight	
220-240V AC 50/60 Hz	COB	-20° +40°C	Included	0,80 Kg	125x170x125 1,0 Kg

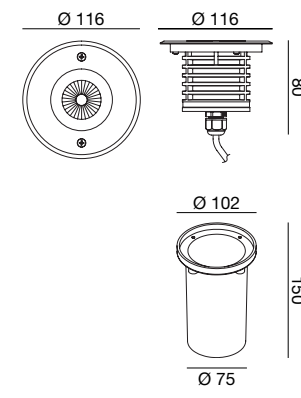

Code	Finishing	Power	Color temper.	Lm Source	Lm System	CRI
6907-02-414	Stainless steel	7,8W	3000K	750 lm	653	> 80

wako 2

6908

Drive-over spot light. Application with outer casing.
Outer casing included. Frame made of AISI 316 stainless steel.

inground spot

wako 2 6908

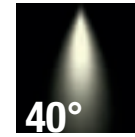

Input voltage	Led type	Operating amb. temp.	Driver	Net weight	
220-240V AC 50/60 Hz	COB	-20° +40°C	Included	0,80 Kg	125x170x125 1,0 Kg

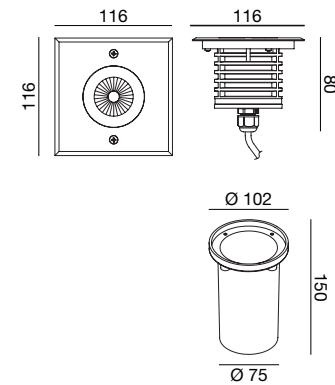

Code	Finishing	Power	Color temper.	Lm Source	Lm System	CRI
6908-02-414	Stainless steel	7,8W	3000K	750 lm	653	> 80

abilene 2

6909

Drive-over spot light 2 lights. Application with outer casing.
Outer casing included. Frame made of AISI 316 stainless steel. Natural anodized finishing.

inground spot



abilene 2 6909

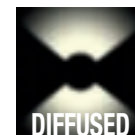

Input voltage	Led type	Operating amb. temp.	Driver	Net weight	
220-240V AC 50/60 Hz	SMD	-20° +40°C	Included	0,50 Kg	150x95x95 0,6 Kg

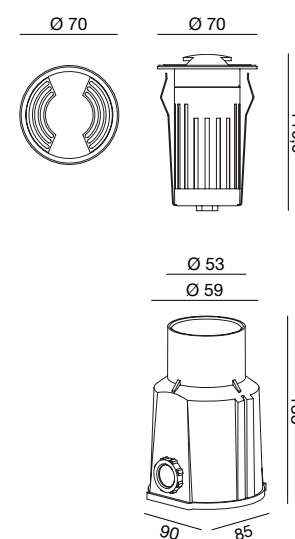

Code	Finishing	Power	Color temper.	Lm Source	Lm System	CRI
6909-02-024	Matt chrome	2,8W	3000K	125 lm	9	> 80

yuma 2

6910

Drive-over spot light 2 lights. Application with outer casing.
Outer casing included. Frame made of AISI 316 stainless steel. Natural anodized finishing.

inground spot

yuma 2 6910



Input voltage	Led type	Operating amb. temp.	Driver	Net weight	
220-240V AC 50/60 Hz	SMD	-20° +40°C	Included	0,50 Kg	150x95x95 0,6 Kg

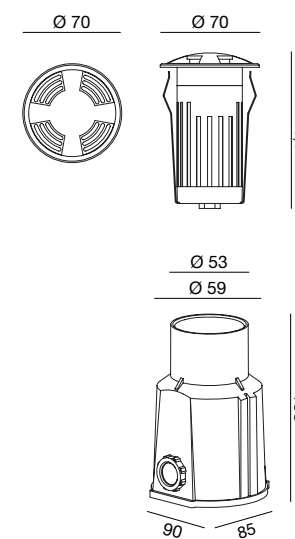

Code	Finishing	Power	Color temper.	Lm Source	Lm System	CRI
6910-02-024	Matt chrome	2,8W	3000K	125 lm	8,5	> 80

spike

tuc

6575

Aluminium structure

spike

tuc 6575

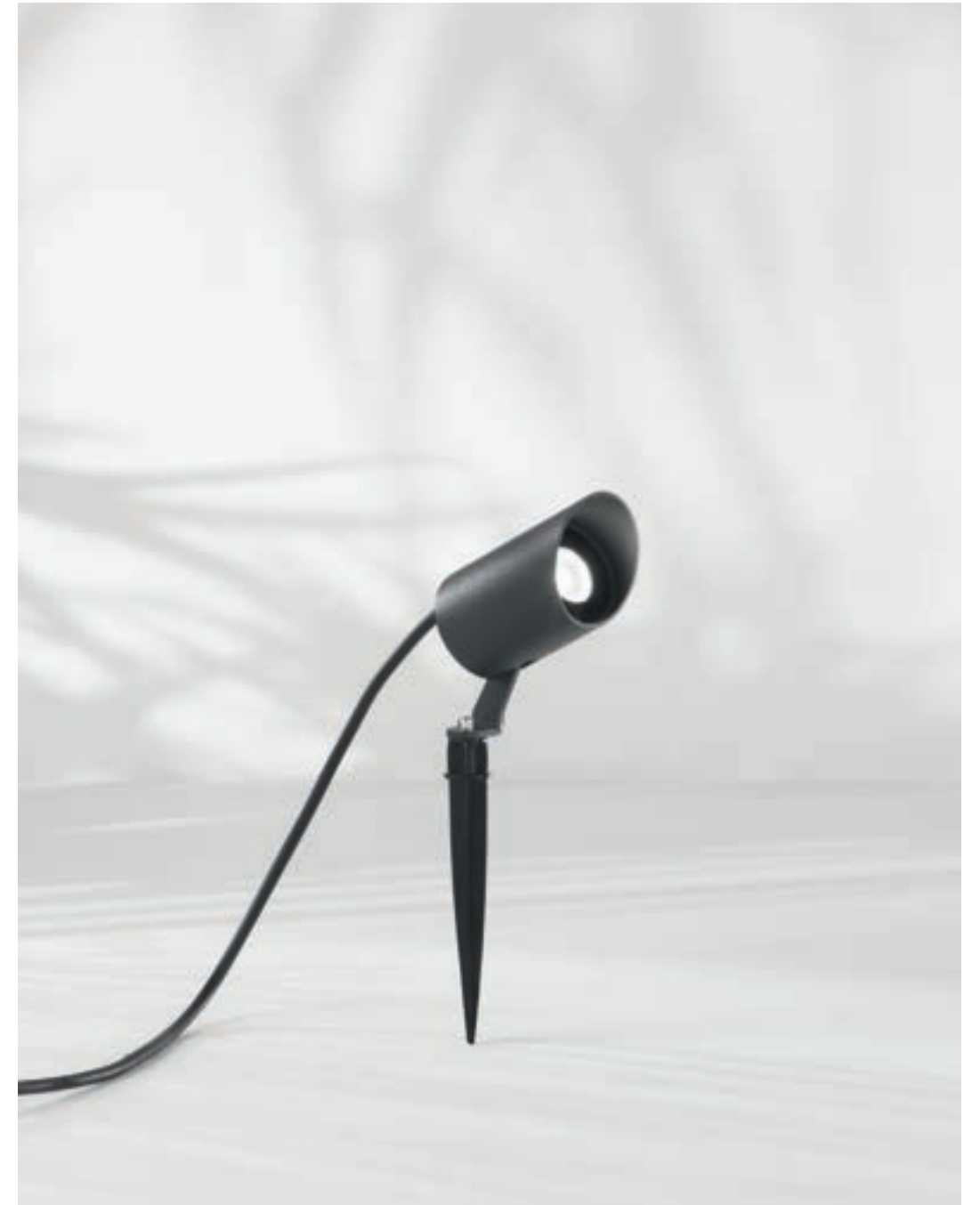
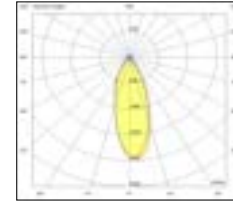

Input voltage	Led type	Operating amb. temp.	Driver	Net weight	
24 VDC	COB	-10° +45°C	Not included	0,48 Kg	105x55x210 0,65 Kg

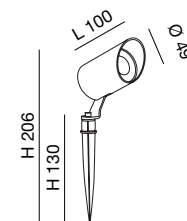

Code	Finishing	Power	Color temper.	Lm Source	Lm System	CRI TYP
6575-71-294	Dark grey	7W	3000K	640	467	90

boris

6550

Die-casting structure

spike

boris 6550

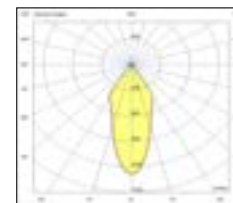

Input voltage	Led type	Operating amb. temp.	Driver	Net weight	
100-240V AC 50/60 Hz	COB	-20° +45°C	Included	0,7 Kg	155x95x200 0,82 Kg

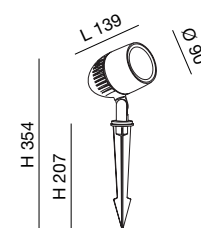

Code	Finishing	Power	Color temper.	Lm Source	Lm System	CRI
6550-71-294	Dark grey	8W	3000K	700	640	> 80

CE IP65 IK08

Energy Class 2 Years Warranty

portable lamp

blend

3738 / 3745

Metal frame and wood

portable lamp



blend 3738 / 3745



Input voltage	Led type	Operating amb. temp.	Net weight	
5V 2A	SMD	-20° +35°C	1,76 Kg	480x265x265 2,19 Kg

Code	Finishing	Power	Color temper.	Lm Source	Lm System	CRI
3738-30-130	Walnut	3W	3000K	320	210	> 80

Input voltage	Led type	Operating amb. temp.	Net weight	
5V 2A	SMD	-20° +35°C	2,59 Kg	940x265x265 3,26 Kg



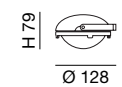
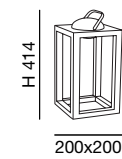

Code	Finishing	Power	Color temper.	Lm Source	Lm System	CRI
3738-35-130	Walnut	3W	3000K	320	210	> 80

Input voltage	Led type	Operating amb. temp.	Net weight	
5V 2A	SMD	-20° +35°C	0,55 Kg	120x120x200 0,69 Kg

Code	Finishing	Power	Color temper.	Lm Source	Lm System	CRI
3745-50-282	Anthracite	3W	3000K	320	210	> 80





 IP54 IK08
 





clamp

3741 / 3745

Metal frame and wood

portable lamp



clamp 3741 / 3745









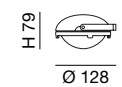
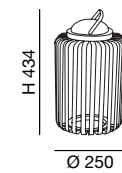

Input voltage	Led type	Operating amb. temp.	Net weight	
5V 2A	SMD	-20° +35°C	1,02 Kg	510x300x300 1,6 Kg

Code	Finishing	Power	Color temper.	Lm Source	Lm System	CRI
3741-30-130	Walnut	3W	3000K	320	210	> 80
3741-30-132	Ash wood	3W	3000K	320	210	> 80

Input voltage	Led type	Operating amb. temp.	Net weight	
5V 2A	SMD	-20° +35°C	0,55 Kg	120x120x200 0,69 Kg

Code	Finishing	Power	Color temper.	Lm Source	Lm System	CRI
3745-50-282	Anthracite	3W	3000K	320	210	> 80





 IP54 IK08
 





caddy

3740 / 3745

Metal and polycarbonate frame

portable lamp



caddy 3740 / 3745









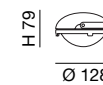
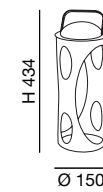

Input voltage	Led type	Operating amb. temp.	Net weight	
5V 2A	SMD	-20° +35°C	1,77 Kg	520x200x200 1,6 Kg

Code	Finishing	Power	Color temper.	Lm Source	Lm System	CRI
3740-30-102	White	3W	3000K	320	210	> 80
3740-30-282	Anthracite	3W	3000K	320	210	> 80

Input voltage	Led type	Operating amb. temp.	Net weight	
5V 2A	SMD	-20° +35°C	0,55 Kg	120x120x200 0,69 Kg

Code	Finishing	Power	Color temper.	Lm Source	Lm System	CRI
3745-50-282	Anthracite	3W	3000K	320	210	> 80





 IP54 IK08
 





armanda

3742

Metal and polycarbonate frame

portable lamp



armanda 3742

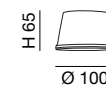
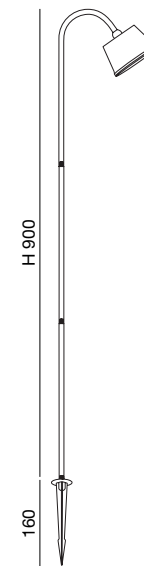

Input voltage	Led type	Operating amb. temp.	Net weight	
5V 2A	SMD	-10° +35°C	0,4 Kg	350x200x100 0,7 Kg

Code	Finishing	Power	Color temper.	Lm Source	Lm System	CRI
3742-72-101	Black	3W	3000K	320	210	> 80
3742-72-102	White	3W	3000K	320	210	> 80
3742-72-361	Corten	3W	3000K	320	210	> 80

Input voltage	Led type	Operating amb. temp.	Net weight	
5V 2A	SMD	-10° +35°C	0,18 Kg	70x100x100 0,21 Kg

Code	Finishing	Power	Color temper.	Lm Source	Lm System	CRI
3742-50-101	Black	3W	3000K	320	210	> 80
3742-50-102	White	3W	3000K	320	210	> 80
3742-50-361	Corten	3W	3000K	320	210	> 80



 IP54 IK04
 
 Energy Class E
 
 2 Years Warranty
 
 Dimmable
 
 Touch Dimmer
 
 Rechargeable



armanda 3742



Input voltage	Led type	Operating amb. temp.	Net weight	
5V 2A	SMD	-10° +35°C	0,61 Kg	360x150x150 0,85 Kg

Code	Finishing	Power	Color temper.	Lm Source	Lm System	CRI
3742-71-101	Black	3W	3000K	320	210	> 80
3742-71-102	White	3W	3000K	320	210	> 80
3742-71-361	Corten	3W	3000K	320	210	> 80

Input voltage	Led type	Operating amb. temp.	Net weight	
5V 2A	SMD	-10° +35°C	0,18 Kg	70x100x100 0,21 Kg

Code	Finishing	Power	Color temper.	Lm Source	Lm System	CRI
3742-50-101	Black	3W	3000K	320	210	> 80
3742-50-102	White	3W	3000K	320	210	> 80
3742-50-361	Corten	3W	3000K	320	210	> 80

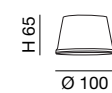
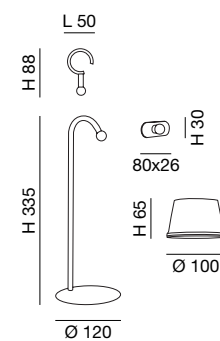

CE  IP54  IK04

 Energy Class  2 Years Warranty  Dimmable  Touch Dimmer  Rechargeable

ITEM CODE INDEX

CODE	NAME	PAGE
2650	PANDORA	80
2796	ARMILLA	81
3225	OBAN MOTION SENSOR	76
3233	OBAN	76
3226	HATTON MOTION SENSOR	77
3229	HATTON	77
3314	DESDY	68
3315	OLLY	70
3525	TRIGO	79
3526	FOLK	78
3603	LAO	50
3680	HAZEL	48
3738	BLEND	116
3740	CADDY	120
3741	CLAMP	118
3742	ARMANDA	122
3745	LED DIFFUSER	116-118-120
6529	TEO	12
6530	STRIKE	18
6534	ELITE BOLLARD	10
6534	ELITE WALL LAMP	36
6535	SPIRIT BOLLARD	16
6535	SPIRIT WALL LAMP	38

CODE	NAME	PAGE
6536	SWEN	20
6537	SMUK BOLLARD	27
6537	SMUK WALL LAMP	59
6538	FOLD	30
6539	PALMER BOLLARD	28
6539	PALMER WALL LAMP	34
6540	JASON	40
6541	CUBA	44
6542	CODY	45
6543	ECTOR	53
6544	ZON	46
6545	GLAMMY	60
6547	OWEN	64
6548	DIUK	66
6550	BORIS	112
6554	GORLA BOLLARD	26
6554	GORLA WALL LAMP	58
6555	CLIP	61
6556	EDO	39
6559	HELI	43
6561	LULY	42
6562	GLUCK	55
6563	PIX	54

CODE	NAME	PAGE
6564	NAGI	14
6565	MANU	72
6566	THIAGO BOLLARD	22
6566	THIAGO WALL LAMP	56
6567	LENA BOLLARD	24
6567	LENA WALL LAMP	57
6571	GLINT	84
6572	DUSK	85
6573	WINK	86
6574	SWAY	88
6575	TUC	110
6576	NICOLE CCT	75
6577	GIAN	74
6786	TRIGG	52
6903	TULIP 2	92
6904	NAIRE 2	94
6905	WILLY 2	96
6906	APACHE 2	98
6907	IRVING 2	100
6908	WAKO 2	102
6909	ABILENE 2	104
6910	YUMA 2	106

ALPHABETICAL INDEX

NAME	CODE	PAGE
ABILENE 2	6909	104
APACHE 2	6906	98
ARMANDA	3742	122
ARMILLA	2796	81
BLEND	3738	116
BORIS	6550	112
CADDY	3740	120
CLAMP	3741	118
CLIP	6555	61
CODY	6542	45
CUBA	6541	44
DESDY	3314	68
DIUK	6548	66
DUSK	6572	85
ECTOR	6543	53
EDO	6556	39
ELITE BOLLARD	6534	10
ELITE WALL LAMP	6534	36
FOLD	6538	30
FOLK	3526	78
GIAN	6577	74
GLAMMY	6545	60
GLINT	6571	84

NAME	CODE	PAGE
GLUCK	6562	55
GORLA BOLLARD	6554	26
GORLA WALL LAMP	6554	58
HATTON	3229	77
HATTON MOTION SENSOR	3226	77
HAZEL	3680	48
HELI	6559	43
IRVING 2	6907	100
JASON	6540	40
LAO	3603	50
LED DIFFUSER	3745	116-118-120
LENA BOLLARD	6567	24
LENA WALL LAMP	6567	57
LULY	6561	42
MANU	6565	72
NAGI	6564	14
NAIRE 2	6904	94
NICOLE CCT	6576	75
OBAN	3233	76
OBAN MOTION SENSOR	3225	76
OLLY	3315	70
OWEN	6547	64
PALMER BOLLARD	6539	28

NAME	CODE	PAGE
PALMER WALL LAMP	6539	34
PANDORA	2650	80
PIX	6563	54
SMUK BOLLARD	6537	27
SMUK WALL LAMP	6537	59
SPIRIT BOLLARD	6535	16
SPIRIT WALL LAMP	6535	38
STRIKE	6530	18
SWAY	6574	88
SWEN	6536	20
TEO	6529	12
THIAGO BOLLARD	6566	22
THIAGO WALL LAMP	6566	56
TRIGG	6786	52
TRIGO	3525	79
TUC	6575	110
TULIP 2	6903	92
WAKO 2	6908	102
WILLY 2	6905	96
WINK	6573	86
YUMA 2	6910	106
ZON	6544	46

SYMBOLS EXPLANATION



Dimmable



Touch dimmer



Adjustable



Rechargeable



Turn&Lock



Motion sensor



Infrared sensor



Crepuscular sensor



Drive over device up to Kg...



Walk over device



Spike included



Downlight hole diameter



All FABAS LUCE products fall within the range of application of the European electromagnetic compatibility E.M.C.directive 2014/30/UE and subsequent amendment and/or the European low voltage directive B.T. 2014/35/UE and subsequent, meet the required specifications and bear "CE" labelling.



Luminaire in which protection against electrical shocks is not just based on the basic insulation but also on an additional safety precautions consisting of connecting the accessible conductive parts to a safety conductor (earth), that is included in the electrical system.



Class II certified equipment, with double insulated wiring. During installation, cut earth wire.



A luminaire in which protection against electric shock relies on supply at safety extra-low voltage (SELV) and in which voltages higher than those of SELV are not generated.

IP20

Protected against solid objects greater than 12 mm.

IP44

Protected against solid objects greater than 1 mm and splashing water.

IP54

Protected against dust and splashing water.

IP65

Fully protected against dust and water jets.

IP67

Fully protected against dust and protected against continuous immersion.

IK

IK	Impact in Joule	Tested weight	Drop height test
IK01	0,15	250 g	5,6 cm
IK02	0,20	250 g	8 cm
IK03	0,35	250 g	14 cm
IK04	0,50	250 g	20 cm
IK05	0,70	250 g	28 cm
IK06	1,00	250 g	40 cm
IK07	2,00	500 g	40 cm
IK08	5,00	1,7 kg	30 cm
IK09	10,00	5 kg	20 cm
IK10	20,00	5 kg	40 cm

BULB INCLUDED



BULB EXCLUDED



Please note: Fabas Luce products are protected by design registrations and patents, imitations will be prosecuted. Place of delivery and jurisdiction for both parties is Monza (Italy). As a rule, only our sales and supply conditions will be applied. We reserve ownership rights to this catalogue. Delivery is ex works. All dimensions in this catalogue are in millimeters. While maintaining the basic characteristics of the product, the manufacturer reserves the right to make modifications at any time and without any prior notice, with the sole aim of improving the quality of the product.

Bulbs: Included in delivery only if declared as included (incl.) in product specifications. Bulbs are consumables and thus not subject to otherwise applicable defect warranty rights.

Spareparts: Are accessible on the website www.fabasluce.it.

Care information: Please only use a soft dry cotton cloth to clean the lamps. Please do not use cleaners or liquids. Please also read the instructions of use and assembly supplied with the lamps. We reserve the right to design modifications. The measurement specifications refer to approximate dimensions.

Retention of title: We reserve ownership rights of the delivered goods until complete payment of all receivables resulting from the contract. These conditions also apply to all future business relations even if this is not expressly agreed again. We are entitled to take back the goods if the buyer breaches the contract.